

9002.3
11.19

SFA

CONTROL BOX ZPS 2.3

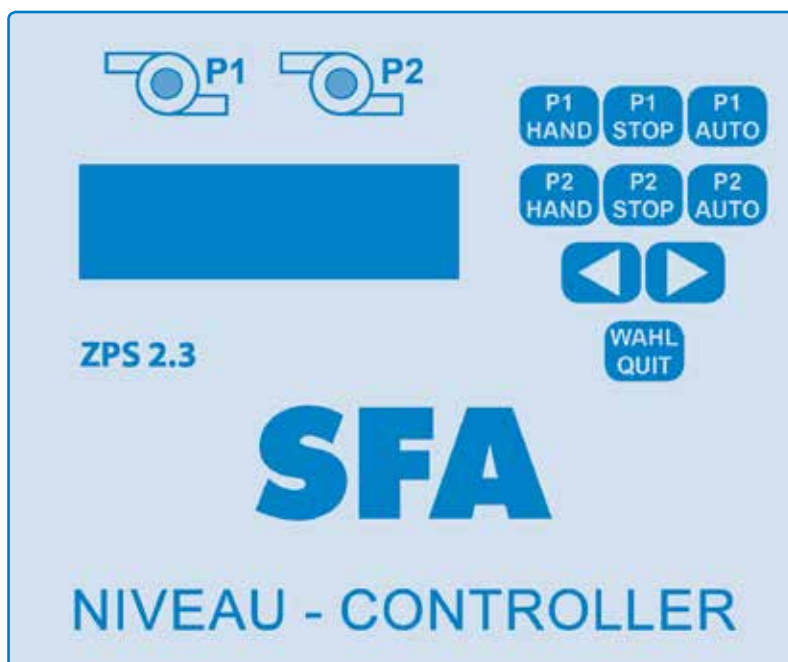

Electronic pump control • Operation and assembly instructions

CONTENTS

1. SAFETY	p 4
2. GENERAL INFORMATION	p 4
2.1 Areas of application	p 4
2.2 General characteristics	p 5
2.3 Technical data	p 5
3. OPERATION OF THE CONTROL SYSTEM	p 6
3.1 Operator control panel and operational elements	p 6
3.1.1 Keys	p 6
3.1.2 Indications on the display	p 7
3.1.3 Normal operation	p 7
3.1.4 Parameter setting	p 8
3.1.5 Information retrieval	p 10
3.1.6 Warnings and notices of malfunction	p 11
3.2 Assembly and electrical connections	p 13
3.2.1 Mechanical fixing	p 13
3.2.2 Mains connection	p 13
3.2.3 Connection of the pump motor	p 13
3.2.4 Connection of the external sensors	p 15
3.2.5 Signal contacts	p 15
3.2.6 Utilisation of the internal sensor	p 16
3.3 Commissioning of the control system	p 16
4. DISPOSAL	p 16

1. SAFETY

WARNING

This device can be used by children who are at least 8 years old and by people with reduced physical, sensory or mental capacities or those without knowledge or experience, if they are properly supervised or if they have been given instructions on safely using the device and the associated risks have been understood. Children should not play with the device. Children should not clean or perform maintenance on the device without supervision.

ELECTRICAL CONNECTIONS:

The electrical installation must be done by a qualified electrical engineer. The device's power supply must be connected to ground (class I) and protected by a high sensitivity differential circuit breaker (30 mA). Devices without plugs must be connected to a main switch on the power supply which disconnects all poles (contact separation distance of at least 3 mm). The connection must be used exclusively to provide the power to the product.

If the power cord is damaged, to prevent possible danger, it must be replaced by the manufacturer, customer service team or a similarly qualified individual.

Labelling of notes in the operating instructions



Danger

This term defines a high risk of danger, which can lead to death or serious injury, if not avoided.



Warning

This term defines a hazard which could cause a risk to the machine and its operation, if it is not taken into account



Dangerous area

This symbol characterises hazards that could lead to death or injury.



Dangerous voltage

This symbol characterises dangers associated with the voltage and provides information on voltage protection.



Property damage

This symbol, in combination with the keyword **ATTENTION**, characterises dangers to the machine and its proper operation.

2. GENERAL INFORMATION

2.1 Areas of application

The twin pump control system ZPS 2.3 is principally used for the regulation of liquid levels. For this,

various sensors for level measurement can be used: floating switches, dynamic pressure, air bubble level measurement systems, external 4- 20mA- sensors. The respective sensors to be employed can be selected via the control program. Then two pumps are directly activated by motor contactors. The pump changeover can be effected via time-control or level-control.

Furthermore, the following devices for error messages are available: acoustic signaler, 4 relay alarm contacts potential-free (programmable for: high-water, combined fault, pump on, malfunction pump, unit okay), safety circuits in the form of a turn-on- and a turn-off-delay, motor current monitoring systems, motor temperature monitoring systems and flood control sensors guarantee a safe operation of the pump station.

The control system is operated via 9 short travel key switches, the program settings are displayed on an LCD display. All settings are saved so that they are available when the control system is restarted. The display language can be changed.

Besides the actual operational parameters, the control system also saves the controlling process and the occurring malfunctions in a record which can be displayed on the LCD display.

2.2 General characteristics

- Clear LCD display
- Hand- Stop- Auto- Function
- 1 acknowledgement button, 2 parameter select buttons
- Menu which can be switched through
- Internal acoustic alarm
- Programmable operation and collective fault signal potential-free
- Floating flood control potential-free
- Omnibus fault message potential-free
- Setting via short travel key switches
- Operating hours counter
- Maintenance interval counter
- Pump start counter
- Recording of fault protocol
- Electronic monitoring of the motor current
- Programmable turn-on-delay
- Programmable pump follow-up
- Programmable pump changeover interval
- Switchable service- and ATEX- mode
- Internal pressure sensor
- Level indication in cm
- 4 digital inputs for thermostatic switch
- 4 digital inputs for floating switch or reed sensor
- 1 analogue input for transmitter 4-20mA
- 1 analogue pressure input 0-100(500) mBar

2.3 Technical data

Operating voltage	230V or 400V/AC/50-60 Hz
Voltage of control system	230V/AC/50-60 Hz
Power consumption	env. 6VA
Pressure range	0-1mWs
Turn-on-delay	0-180 sec
Follow-up time	0-180 sec
Runtime monitoring	0-300 sec
Turn-on-delay 2 pumps	0-60 sec.
Motor current limitation	0.5- 14A
Fault protocol memory	32 memory positions
Maintenance interval counter	0 – 365 days, adjustable
Operating temperature range	-20 - +60°C
Dimensions	180x180x90 mm
Max. pre-fuse	20A
Potential-free alarm contact	3 A max.
Degree of protection	IP 65
Housing	Polycarbonate

3. OPERATION OF THE CONTROL SYSTEM



The electronic pump control is equipped with a key lock. To unlock, please press and hold  (Selection) for 3 seconds. There will be an indication in the display. Approximately 1 minute after the last actuation of any key the keyboard will be locked again.



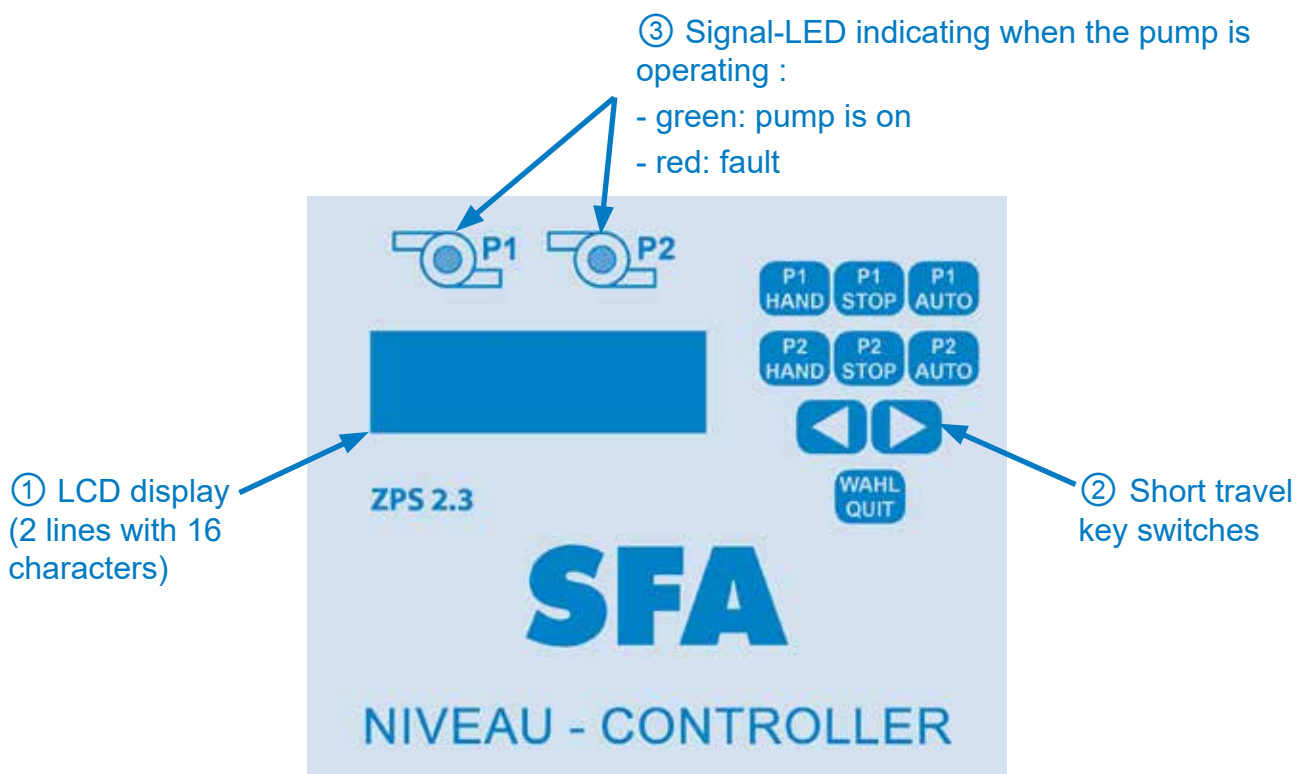

The automatic key lock after 1 minute can be deactivated in the menu, e.g. to aid with maintenance works. The keylock is enabled with the service mode switched-off only

3.1 Operator control panel and operational elements



3.1.1 Keys

 (MANUAL)	By pressing this key, the preferred pump is switched on without delay. Except for the motor monitoring, no other function of the program is enabled. The green LED ③ of one pump flashes. ATTENTION : If the ATEX mode is enabled, the pump can only be started if the turn-on level is exceeded ! The green LED is flashing. ATTENTION : The pump will be switched after 2 minutes. A restart of the pump is possible immediately.
	Stops the pump motor without follow-up. The green LED goes out.
	The pumps are actuated via the level evaluation of the selected sensor (see point 3.1.4). All monitoring and safety functions are executed according to the presetting.



	<p>By pressing one of these two keys, the menu is switched to the next menu item in the indicated direction.</p> <p>If the menu is enabled, (see key SELECTION ) , the set values can be modified via those keys (some modifications are only possible in the operating mode "Stop"). The more you press the key, the faster it scrolls.</p>
 (Selection/ Stop)	<p>By pressing this key, the set values in the active menu are enabled. The activated text will start to flash (modification mode) and can be modified by using  .</p> <p>By repeatedly pressing these keys, the set value becomes permanent (flashing stops), which means that it will be saved even if the control system is turned off.</p>

3.1.2 Indications on the display

Normal operation :

During operation of the control system, the upper line of the LCD display indicates the actual liquid level or the switching status of the floating switch. In the lower line of the display, information about the actual operational status of the control system of the pumps P1 and P2 will appear. If one pump is running, the active motor current and the operating condition are displayed alternately. In case of failure, the actual failure status is displayed (see point 3.1.6). The LEDs of the pump will flash with a red light.

Parameter setting :





In the upper line, the designation of the parameter is displayed; the lower line displays the current value of the parameter. The values can be modified by using the keys  and  as described in 3.1.1.



Information retrieval :

Information values such as maintenance intervals, operating hours, pump starts and fault list can be displayed and modified in the same way as the control parameters. Only the fault list saves 32 positions respectively. The recording is carried out by means of a shift register, which means that the earliest error is deleted automatically.

3.1.3 Normal operation

During normal operation, the three operating modes are indicated on the display as follows.

Pressed key	2nd line on display	Signification
 	Hand 1 P1 4,7A Hand 2 P2 0,0A	The pump P1 and the pump P2 have been switched on manually.
 	Stop 1 P1 0,0 A Stop 2 P2 0,0 A	The pump motors are switched off. The level evaluation, including the flood control, remains enabled. <div style="text-align: center; background-color: #e0e0e0; padding: 5px;">  WARNING </div> <div style="background-color: #0056b3; color: white; padding: 5px; text-align: center;"> The pump motor is not activated during flooding alarm. </div>

Pressed key	2nd line on display	Signification
	Auto P1 4,7A	The pumps are switched on or off, according to the level requirement. Here, pump P1 is active at the moment.
	Auto P2 0,0A	

3.1.4 Parameter setting

The following table shows the setting options and the effects of the individual parameters. A parameter can be selected via the menu selection  (see point 3.1.1).





WARNING





For reasons of safety, the modification mode for the parameters can only be enabled in the "Stop"- operation (key ).

1st line on display	2nd line on display (set value)	Signification
base load OFF	Base load off \leq Peak load off and Base load on \leq Peak load on	Stop level base load. Modifications only during Stop-operation!
base load ON		Start level base load. Modifications only during Stop-operation!
peak load OFF		Stop level peak load, 2 nd pump will switched off. Modifications only during Stop-operation!
peak load ON		Start level peak load, 2 nd pump will switched on. Modifications only during Stop-operation!
high water (High water HW)	Peak load on < HW and HW \leq final value of level sensor	Flooding- alarm- level  WARNING Additionally, this level is constantly evaluated on the input for the floating switch HW, independent from the selected level transmitter. Thereby, if necessary, 2 different HV-levels can be realised with 2 different transmitters. Modification only possible in Stop-mode !



1st line on display	2nd line on display (set value)	Signification
run-time (Run-time change after)	is deactivated until 300 sec.	At transgression of the adjusted time during base load operation pumps do change. 'IS DEACTIVATED' effects that each modification occurs only after reaching the level 'BASE LOAD OFF'. This function may be used to monitor the flow rate of the pump. Here unto a time above the normal pump-down time has to be adjusted. A switch occurs if the requested pump has not pumped down under the switch-on point within the adjusted time. After 3 consecutive the error "Run-time Alarm" occurs.
delay time	0 to 180 sec	The turn-on delay of the pump only functions after a restart of the control system (e.g. after a power failure). With "normal" switch operation via the levels N1 and N2, this setting is not relevant. This function may be used to avoid the simultaneous switch-on of several pumping stations after a mains failure.
overrun	0-180 sec.	After having reached the turn-off level, the pumps are still running for the adjusted amount of time.
Interpump delay	0 to 60 sec.	When both pumps are requested at the same time, the second pump will be switched on after the adjusted time, e.g. to avoid mains overload.
pumps together	- is activated - is deactivated	If this function is deactivated, only one pump works, e.g. to avoid overload of the wastewater system.
max. current P1 max. current P2	0,0 to 14,0 A	If the adjusted value is reached, the monitoring system of the pump motor current effectuates the shutdown of the pump, accompanied by a notice of malfunction. The malfunction has to be acknowledged manually by pressing the key  . Attention : If the nominal current is adjusted to 0 A <u>no monitoring</u> of the motor's charging rate occurs !
24 hours start	is activated is deactivated	Pump P1, P2 are briefly started if no request occurs by the switch-on level within 24 hours. If the ATEX mode is enabled, the 24h starting is only taking place if the turn-off level is exceeded.

1st line on display	2nd line on display (set value)	Signification
acoustic alarm	is activated is deactivated	The internal acoustic transmitter is switched on or off. This setting has no influence on the potential-free alarm signal.
interval alarm	is activated is deactivated	The alarm relay for the non-floating alarm contact is synchronized or produces a permanent signal.
pump changeover	is activated is deactivated	If the pump changeover is enabled a changeover of the pumps occurs after each pump down.
P1: therm.fault P2: therm. fault Thermostatic switch P1 TH1 control loop TH2 control loop P2 TH3 control loop TH4 control loop	is activated is deactivated	The evaluation of the thermal contacts TH1 and TH3 (control loop) can be deactivated. If this contact is open, the pump is shut down and a fault is signalled. After the contact TH1/TH3 (clipping circuit) has cooled down and been closed again, the pump restarts automatically. After cooling down, the activation of the pump in case of malfunction TH2/TH4 can only be effected by acknowledging the malfunction by pressing the key  . This contact can not be deactivated by means of the software. If the pump is not equipped with thermal contacts, a bridge has to be inserted as a substitution for TH2/TH4.
phase error	is activated is deactivated	The energization of all the 3 phases and the proper phase sequence at the mains input are monitored. To be disabled for 230 V pumps.
ATEX - Mode	is activated is deactivated	If the ATEX mode is enabled, it is not possible to switch on the pump if the turn-off level is under-run. This also applies for the HAND function and the 24h starting.
service mode	is activated is deactivated	If the service mode is disabled, it is not possible to set the parameters. The modification mode is only possible for the service mode itself.
level controller (=Level control)	intern. converter float switch 4-20mA Interface	Level measurement via dynamic pressure measurement Level measurement via external sensor Level measurement via floating switch
intern. converter	matching (=calibration)	By pressing the key sequence     , the zero point of the internal converter is adjusted. The adjustment has to be carried out while the pilot tube is emerged (with barometric pressure). This adjustment is to be carried out by a service technician only.

1st line on display	2nd line on display (set value)	Signification
20 mA => level	1 - 1250 cm	Final value of the sensor at 20 mA
Signal contact 1-4	Possible signals : - Fault high water - Collective fault - Pump 1 on - Pump 2 on - Fault pump 1 - Fault pump 2 - system OK	Kind of signal on contacts 1-4 The collective fault signal can be timed
Language	Deutsch English, etc...	Setting of the menu language
DD.MM.YYYY hh:mm	see adjustments	Date and time
Keylock	on / off	The keylock can be disabled. The key lock is enabled with the service mode switched-off only.
WLAN reset		Disabled
Fault protocol	- - -	After having pressed the key  , the protocol can be paged through by pressing the keys  . It is not possible to change the data. The last 32 malfunctions are saved in chronological order.



3.1.5 Information retrieval

The following table shows the signification of the operational data of the control system :

1st line on display	2nd line on display (informational value)	Signification
up time	hours: X (in hours)	Shows the cumulative operating times of the control system in hours. The value can be reset to 0 by pressing the keys  .
total pump hours	P1/P2 XXXX/XXXX (in hours)	Shows the cumulative runtimes of the pumps in hours. The value can be reset to 0 (separately for both pumps) by pressing the keys  .
pump starts	P1/P2 XXXX/XXXX (in number)	Shows the number of pump starts. The value can be reset to 0 (separately for both pumps) by pressing the keys  .
next maintenance	within days:XXXX (in days)	Shows the number of days until the next maintenance. The information is saved at intervals of 4 hours. The initial value can be preset between 365 and 0 days.

3.1.6 Warnings and notices of malfunction

The following warnings and notices of malfunction can be indicated on the display. In the fault protocol, the data will be recorded :

2nd line on display	Signification	Alarm	Protocol signal
Fault load	<p style="text-align: center;"> DANGER</p> <p> Current flow below 0,5 A. Either no pump is connected, or a phase is lacking.</p> <p>This malfunction can be suppressed, if for the motor current monitoring 0.0A are set in the menu "current limitation".</p> <p style="text-align: center;">ATTENTION</p> <p> If both pump currents are set to 0,0A, the control system is running in the test mode. The pumps are not deactivated. All functions of the control system are enabled. The motor current is <u>not</u> monitored.</p>	Yes	Last
Fault pump 1 Fault pump 2	The motor current monitoring system has detected an exceedance of the set limit value and has shut down the pump motor.	Yes	IP1
Fault high water	The HW-sensor reports an alarm and switches on the pump. The HW-malfunction acknowledges itself when the turn-on level is reached again.	Yes	HW
Fault I<3mA	The external sensor is selected, but the current is <3mA. There might be a disconnection, or the sensor might be defective. The malfunction acknowledges itself when the sensor current is within the normal range.	Yes	I<3mA
Fault SW	The floating switches are connecting in the wrong sequence (e.g. the lower floating switch is open when the upper floating switch closes).	Yes	SW
Pump 1 Fault TH1 Fault TH2 Pump 2 Fault TH3 Fault TH4	Activation of the thermal control of the pump motor. The malfunction TH1 and TH3 acknowledge themselves after the motor has cooled down; TH2 and TH4 have to be acknowledged manually.	Yes	Pump 1 TH1 TH2 Pump 2 TH3 TH4
Phase fault	A phase of the power supply has failed.	Yes	Dreh
Fault ATEX	The ATEX mode is activated and the level is below the switch-off point of the selected pump.	Yes	Atex
Run-time alarm	The runtime monitoring of the pump has been exceeded 3 times in succession.	Yes	Time

3.2 Assembly and electrical connections

DANGER



All electrical connections are to be established by an authorised professional only. Settings and adjustments on the control system as well as the commissioning of the control system are to be carried out by qualified persons only.

3.2.1 Mechanical fixation

The control system has to be fixed on an even surface. In order to fasten the control system, the housing cover has to be opened.

3.2.2 Mains connection

The left cable gland is intended for the cable entry of the mains cable. The separate cables are to be clamped into the spring terminals in the manner described below. According to the motor which is used, a single-phase or a three-phase connection can be established.

ATTENTION



The power supply has to be secured by an independent all-pole fuse which can be switched off (max. 20 A).

3.2.3 Connection of the pump motor

Either mono-phase or three-phase motors may be connected according to the below shown connection diagram.

Connection of a 3-phase Motor :

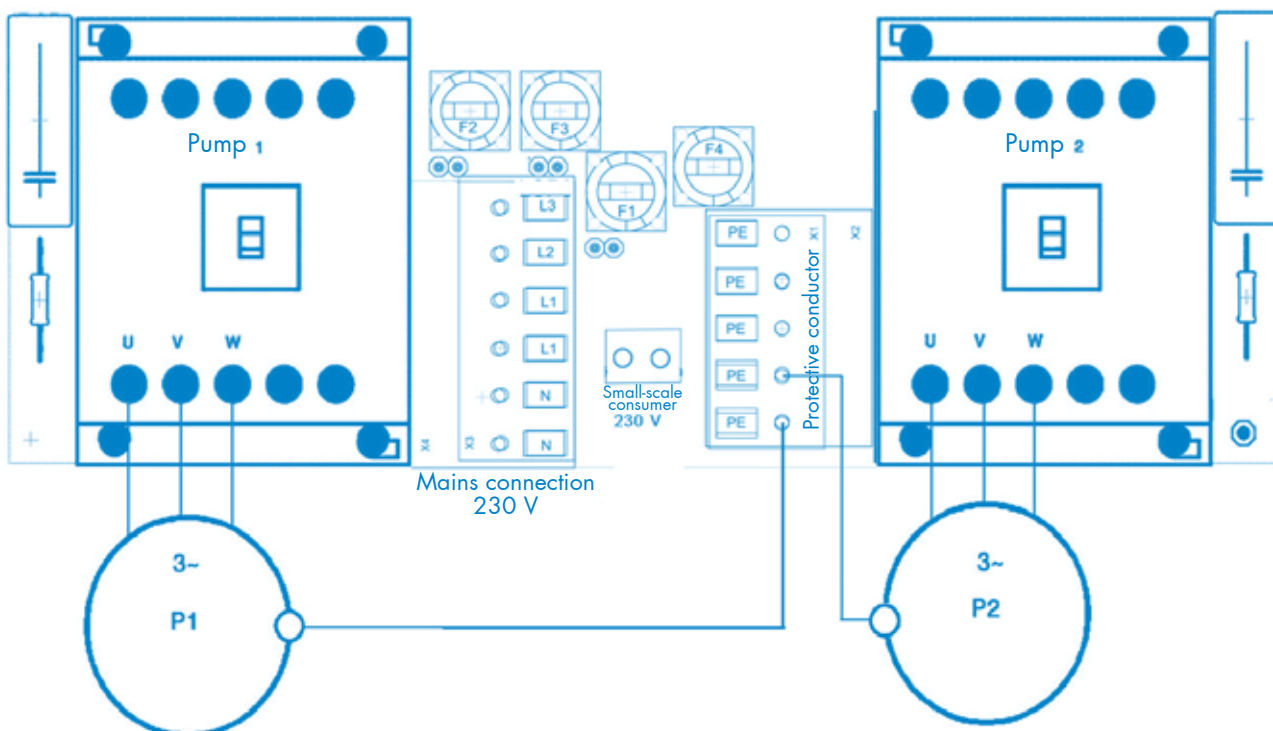

Connection of a single-phase Motor with internal capacitor :

For 230V pumps, a bridge between N-L2 is required in the mains connection.

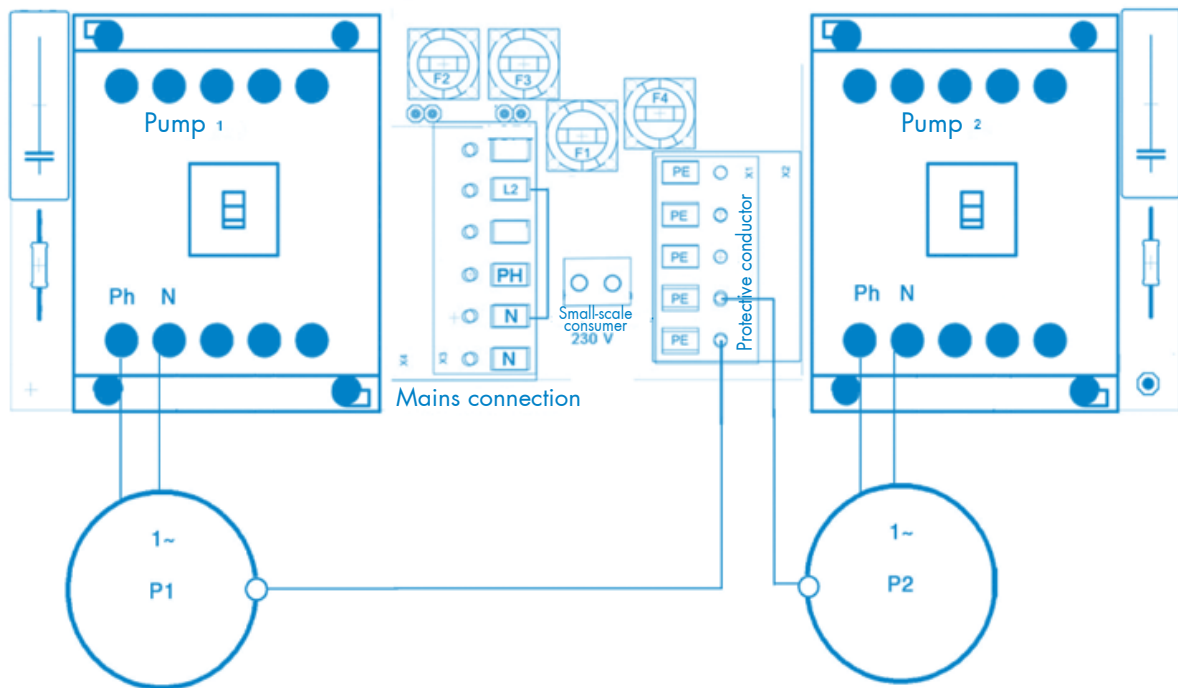

Connection of a single-phase Motor with external capacitor :

For 230V pumps, a bridge between N-L2 is required in the mains connection.

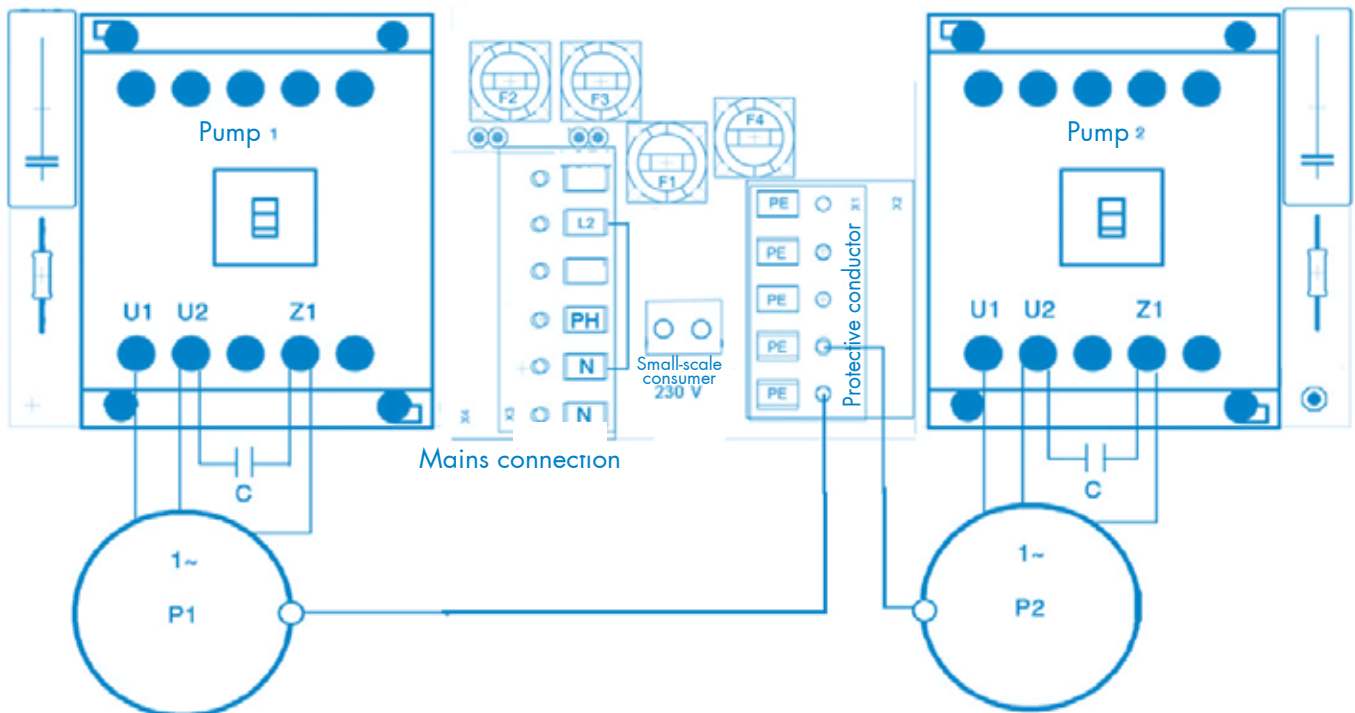

3.2.4 Connection of the external sensors

The external sensors are connected by means of the terminal strip on the upper circuit board. The active sensor can be selected in the menu “level control” and “therm. malfunction”.

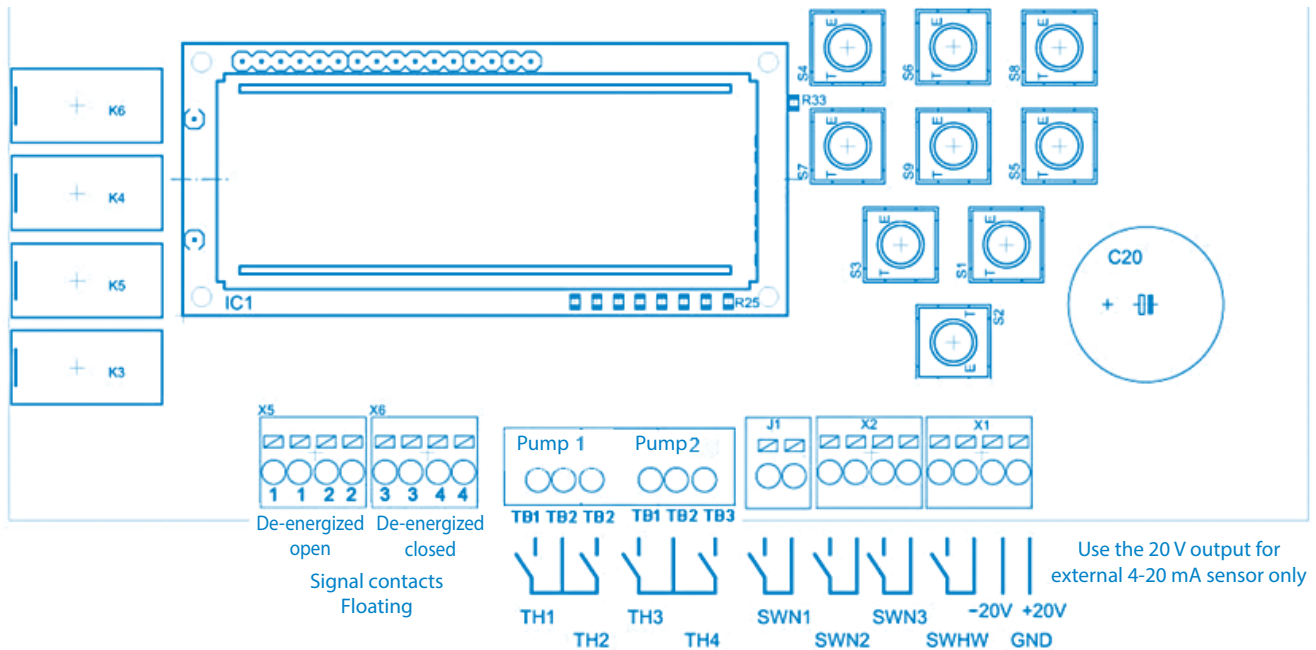

If the thermostatic switches TH2 and TH4 are not necessary, bridges have to be inserted on those contact points. The thermostatic switches TH1 and TH3 can be deactivated via the menu therm. malfunction.

The floating switches have to close when they are floating on the surface. The floating switches have to be connected floatingly. The required signal voltage is generated in the control system and amounts to 5V.

Assignment of the float switches:

- SWN1 = pumps 1 and 2 off
- SWN2 = pump on
- SWN1 = peak load 2nd pump switched on
- SWHW = high water alarm

⚠ DANGER



For the usage in explosion-prone areas, either floating switches with the corresponding permission, or intrinsically safe cut-off relays have to be used.

The external sensor has to supply a measurement current between 4 and 20mA. The final value of 20 mA can be adjusted in the menu, so the indication may occur in cm.

3.2.5 Utilisation of the internal sensor

An internal sensor, a pressure sensor 0 to 10 kPa is used (0 to 1mWs, 0 to 100 mbar). Other measurement ranges can be realised on demand. On the lower side wall, a hose screw connection 6/8mm is located which is intended for the connection of the immersion pipe. The sensor used is designed as a differential pressure converter, so that barometric variations are eliminated. The

menu item “internal converter – adjustment” serves for the accurate adjustment of the zero point.

ATTENTION



In order to equalise possible air leaks inside the pneumatic level measuring device, the pilot tube has to be fully emerged from the water after completion of the pumping process. For this purpose, the adjustment of a follow-up time of the according duration is necessary. Alternatively, the small-size compressor set for the air bubbler level measurement system can be used.

3.2.6 Signal contacts

The 4 potential-free signal contacts are located in the upper circuit board (left).

The 4 signal contacts are free programmable: the contacts 1 and 2 are opened in case of power failure and the contacts 3 and 4 are closed in case of power failure.

If the power supply of the control is okay, then the signal contacts are closed in case of a fault or signal.

3.3 Commissioning of the control system

After the complete connection of the pump cables, the mains power supply and the level sensor, the parameters can be set after the mains voltage has been applied. Only trained personnel are allowed to set those parameters.

Now the plant can be commissioned by pressing the key . During the conduction of several test runs, the set switch points have to be checked, and, if necessary, corrected.

Checking of the control system without pumps :

In order to be able to check the control system without a pump, the following standard settings are required :

1. Connect the control system to a single-phase network (connection of N and L1)
2. Set motor current limitations for both pumps to 0.0 A
3. Switch off rotary field
4. Bridge thermal contacts TH2 AND TH4
5. Disable thermic error for pump 1 and pump 2.

If the respective level sensors are connected, all program functions can be checked without having to connect the pumps.

4. DISPOSAL



Only for EU-countries

Do not dispose of the control system with the regular household garbage!

According to the European directive 2012/19/EG about waste electric and electronic equipment and the transposition into national law, used electric tools, have to be collected separately and recycled in an environmentally compliant manner.

Contact Information
SFA Australia Pty Ltd Unit
10, 25 Gibbes Street,
Chatswood NSW 2067
Phone +1300 554 779
E: GENERAL ENQUIRIES
info@saniflo.com.au
E: TECHNICAL
SUPPORT
technical@saniflo.com.au